

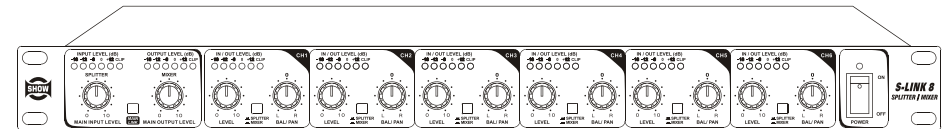

THE UNIVERSE OF INSTALLATION

SPLITTER/MIXER

User's Manual



SHOW® is a registered trademark of
SEIKAKU TECHNICAL GROUP LIMITED

SEIKAKU TECHNICAL GROUP LIMITED
NO.1 LANE 17, SEC.2, HAN SHI WEST ROAD, TAICHUNG 40151, TAIWAN

S-LINK8



INDEX

01 SAFETY RELATED SYMBOLS	1
02 WARNING	1
03 IMPORTANT SAFETY INSTRUCTION	2
04 INTRODUCTION	3
05 CONTROL ELEMENTS	3
06 APPLICATIONS	6
07 INSTALLATION & CONNECTIONS	9
08 BLOCK DIAGRAM	11
09 TECHNICAL SPECIFICATINS	12

IMPORTANT!

Please read this manual carefully before operating this unit for the first time.

All rights reserved to SEIKAKU. All features and content might be changed without prior notice. Any photocopy, translation, or reproduction of part of this catalogue without written permission is forbidden. **Copyright © 2009 SEIKAKU GROUP**

TECHNICAL SPECIFICATIONS

AUDIO INPUTS	Connectors	XLR and 1/4" TRS
	Type	RF filtered, servo-balanced input
	Impedance	50 kOhms balanced, 25 kOhms unbalanced
	Nominal operating level	-10 dBV to +4 dBu
	Max. input level	+21 dBu balanced and unbalanced
	CMRR	Typ. 40 dB, > 55 dB @ 1 kHz
AUDIO OUTPUTS	Connectors	XLR and 1/4" TRS
	Type	Electronically servo-balanced output stage
	Impedance	60 Ohms balanced, 30 Ohms unbalanced
	Max. output level	+22 dBu balanced and unbalanced
SYSTEM SPECIFICATIONS	Frequency response	5 Hz to 200 kHz, +/- 3 dBu
	S/N ratio	>95 dBu, unweighted, 22 Hz to 22 kHz
	THD	≤0.002 % typ. @ +4 dBu, 1kHz, gain 1
FUNCTION CONTROLS	Main input level	variable
	Main output level	variable
	Level	variable for each channel
	Balance/pan	placing in the stereo field
FUNCTION SWITCHES	Main Link	links the main input signal to the main output
	Split/mix	changeover from split to mix mode for each channel
INDICATORS	Input level (main)	6-digit LED display: -18/-12/-6/0/+12/Clip
	Output level (main)	6-digit LED display: -18/-12/-6/0/+12/Clip
	Input/output level	6-digit LED display: -18/-12/-6/0/+12/Clip
POWER SUPPLY	Mains Voltages	USA/Canada 120V ~, 60 Hz
		U.K./Australia 240V ~, 50 Hz
		Europe 230V ~, 50 Hz
	Power Consumption	max. 30 Watts
	Fuse	100 - 120 V ~: T 500 mA H 220 - 240 V ~: T 315 mA H
Mains Connection	Standard IEC receptacle	
PHYSICAL	Dimensions (H*W*D)	483(W)×195(D)×44(H)mm (19"×7.54"×1.7")
	Net Weight	2.6 kg(5.73lb)
	Shipping Weight	3.5 kg

SAFETY RELATED SYMBOLS



The symbol is used to indicate that some hazardous live terminals are involved within this apparatus, even under the normal operating conditions.



The symbol is used in the service documentation to indicate that specific component shall be only replaced by the component specified in that Documentation for safety reasons.



Protective grounding terminal.



Alternating current /voltage.



Hazardous live terminal .



ON: Denotes the apparatus turns on.



OFF: Denotes the apparatus turns off, because of using the single pole switch, be sure to unplug the AC power to prevent any electric shock before you proceed your service.

WARNING: Describes precautions that should be observed to prevent the danger of injury or death to the user.



Disposing of this product should not be placed in municipal waste and should be separate collection.

CAUTION: Describes precautions that should be observed to prevent danger of the apparatus.

WARNING

• Power Supply

Ensure the source voltage matches the voltage of the power supply before turning ON the apparatus.

Unplug this apparatus during lightning storms or when unused for long periods of time.

• External Connection

The external wiring connected to the output hazardous live terminals requires installation by an instructed person, or the use of ready-made leads or cords.

• Do not Remove any Cover

There are maybe some areas with high voltages inside, to reduce the risk of electric shock, do not remove any cover if the power supply is connected.

The cover should be removed by the qualified personnel only.

No user serviceable parts inside.

• Fuse

To prevent a fire, make sure to use fuses with specified standard (current, voltage, type). Do not use a different fuse or short circuit the fuse holder.

Before replacing the fuse, turn OFF the apparatus and disconnected the power source.

• Protective Grounding

Before turning the product ON, make sure that it is connected to Ground. This is to prevent the risk of electric shock. Never cut internal or external Ground wires. Likewise, never remove Ground wiring from the Protective Ground Terminal.

Never cut off the internal or external protective grounding wire or disconnect the wiring of protective grounding terminal.

The apparatus shall be connected to a mains socket outlet with a protective earthing connection.

• **Operating Conditions**

This apparatus shall not be exposed to dripping or splashing and that no objects filled with liquids, such as vases, shall be placed on this apparatus.

To reduce the risk of fire or electric shock, do not expose this apparatus to rain or moisture.

Do not use this apparatus near water. Install in accordance with the manufacture-r's instructions. Do not install near any heat sources such as radiators, heat registers, stoves, or other apparatus (including amplifiers) that produce heat. Do not block any ventilation openings.

No naked flame sources, such as lighted candles, should be placed on the apparatus.

IMPORTANT SAFETY INSTRUCTIONS

- Read these instructions.
- Follow all instructions.
- Keep these instructions.
- Heed all warnings.
- Only use attachments/accessories specified by the manufacturer.

• **Power Cord and Plug**

Do not defeat the safety purpose of the polarized or grounding type plug.

The mains plug is used as the disconnect device, the disconnect device shall remain readily operable.

A polarized plug has two blades with one wider than the other. A grounding type plug has two blades and a third grounding prong. The wide blade or the third prong are provided for your safety. If the provided plug does not fit into your outlet, consult an electrician for replacement of the obsolete outlet.

Protect the power cord from being walked on or pinched particularly at plugs, convenience receptacles, and the point where they exit from the apparatus.

• **Cleaning**

When the apparatus needs a cleaning, you can blow off dust from the apparatus with a blower or clean with rag etc.

Don't use solvents such as benzol, alcohol, or other fluids with very strong volatility and flammability for cleaning the apparatus body. Clean only with dry cloth.

• **Servicing**

Refer all servicing to qualified personnel. To reduce the risk of electric shock, do not perform any servicing other than that contained in the operating instructions unless you are qualified to do so .

Servicing is required when the apparatus has been damaged in any way , such as power supply cord or plug is damaged , liquid has been spilled or objects have fallen into the apparatus, the apparatus has been exposed to rain or moisture , does not operate normally, or has been dropped.

BLOCK DIAGRAM

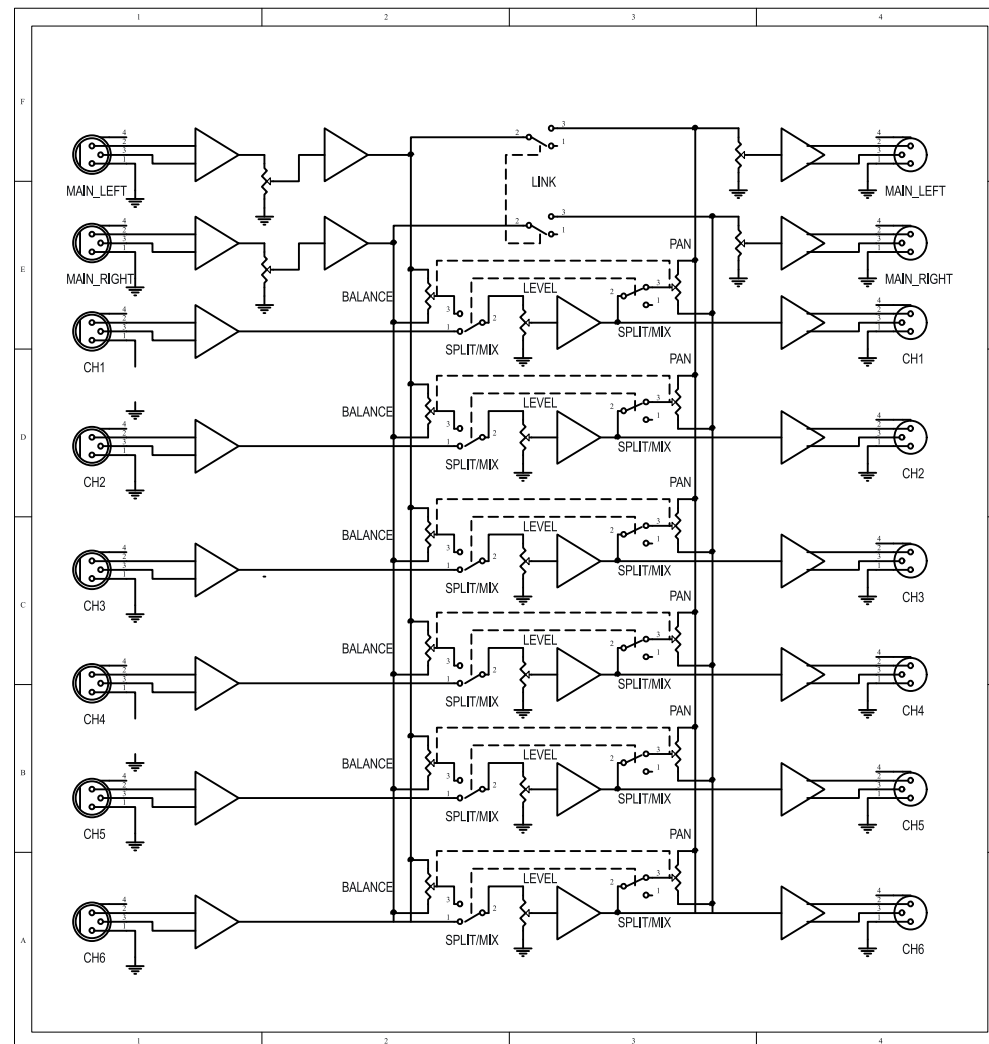

b. In Line Connection

For these applications, the S-LINK8 provides XLR connectors and 1/4" TRS phone jack to easily interface with most professional audio devices. Follow the configuration examples below for your particular connection.

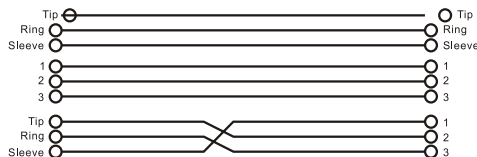
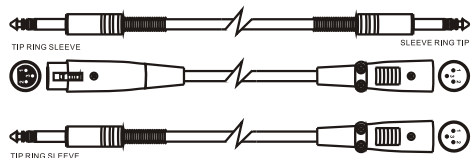
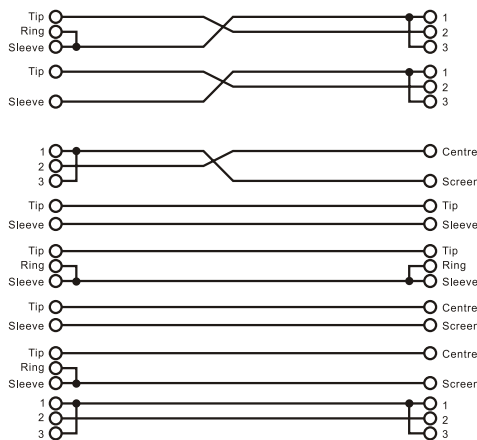
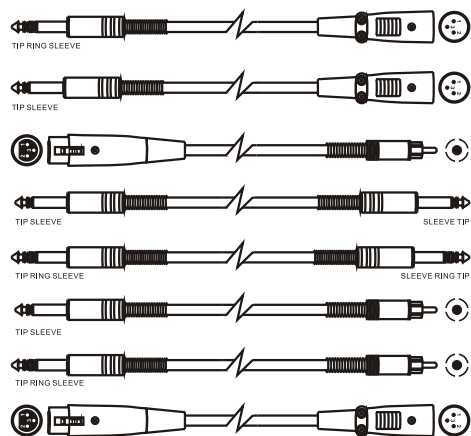
• Balanced

• Unbalanced

Rack Mounting

The most secure mounting is on a universal rack shelf available from various rack manufactures or your music dealer. The S-LINK8 fits into one standard 19" rack unit of space. Please allow at least an additional 4" depth for the connectors on the rear panel. Be sure that there is enough air space around the unit for sufficient ventilation and please do not place the S-LINK8 on high temperature devices such as power amplifiers etc. to avoid overheating.

INTRODUCTION

Thank you very much for expressing your confidence in our products by purchasing S-LINK8 splitter/mixer. S-LINK8 is the good solutions for many problems of the large scale sound reinforcement systems and PA applications, and it can be used as a splitter or a mixer.

For splitter application, just apply the main signal input from the MAIN IN sockets, and select the SPLITTER mode for each individual channel, then six mono outputs can be gotten. By depressing the MAIN MIX button, two further outputs can be provided.

For mixer application, select the MIXER mode for individual channel, and feed the input signal from the mono input, then six input signals can be mixed together, and output from the MAIN OUT. By depressing the MAIN MIX button, two further inputs can be provided.

Please reserve your time to read this manual before running the unit, and you will be the real master of your S-LINK8.

The S-LINK8 splitter/mixer is equipped with following features:

- 1 rack size.
- SPLIT / MIX switch for each mono channel.
- 2 input, 6+2 outputs splitter.
- 8 Balance / Pan control for each channel.
- Main input and output level control.
- MAIN LINK function allows to route the MAIN IN signal to MAIN OUT, vice versa.
- Level meters for each stage.
- XLR balanced connectors for 4 mono channels, and TRS type for another 2 mono channels.
- Dual voltage unit for global operation.

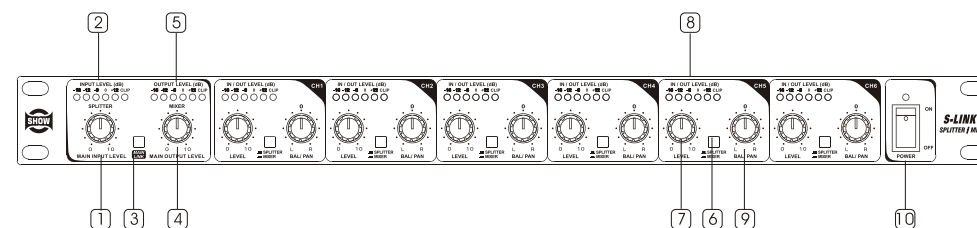
CONTROL ELEMENTS
FRONT PANEL

1. MAIN INPUT LEVEL control

This knob is used to adjust the level of the main input signal, and its adjustable range goes from $-\infty$ to +10dB.

2. INPUT LEVEL meter

This 6-digit meter tells you the level of the main input signal. While the Clip LED lights up, please turn down the main input signal, otherwise, the system will be distorted.

3. MAIN LINK control

Use this switch to link the MAIN IN with the MAIN OUT.

4. MAIN OUTPUT LEVEL control

This knob is used to adjust the level of the main output signal, and its adjustable range goes from $-\infty$ to +10dB.

5. OUTPUT LEVEL meter

This 6-digit meter tells you the level of the main output signal. While the Clip LED lights up, please turn down the main signal at either each input stage or the main output stage, otherwise, the system will be distorted.

6. SPLIT / MIX

Use this switch to select the specific operational mode for each individual mono channel.

For SPLITTER mode, please let the switch released, and the main input signal can then be split into each mono channel output.

For MIXER mode, please engage this switch, and now, the mono channel input signal will be sent to the main output bus, combined with the main input signal on condition that the MAIN LINK is activated, you can get the mixed signal output from the MAIN OUT sockets.

Further, also for the MIXER mode, you can route the mono channel input signal to the mono channel output directly.

7. LEVEL control for each channel

This knob is used to adjust the level of each mono channel, and its adjustable range goes from $-\infty$ to +10dB, definitely, In SPLITTER mode, this control is used to determine the output level of each individual mono channel. While in MIXER mode, this control can be used to determine how much the mono channel input signal is sent to the main output bus and/or each individual mono channel output.

INSTALLATION & CONNECTIONS

Mains Connection

This is a dual voltage unit. Please ensure that the S-LINK8 is set to the correct supply voltage before plugging the power cord into the wall outlet, use the same fuse as marked on the fuse holder at the AC power connection socket.

Do not insert power cord into the unit until voltage has been correctly set. Do not plug the power cord into AC power until voltage has been correctly set.

The mains connection of the S-LINK8 is made by using the enclosed mains cord and a standard IEC receptacle. It meets all of the international safety certification requirements.

Audio Connection

The S-LINK8 presents with balanced XLR connectors and 1/4" TRS phone jack, it can be interfaced by several ways to support a variety of applications without any signal loss.

a. Wiring Configuration

Either the 1/4" TRS (Tip-Ring-Sleeve) phone jack or the XLR servo connector can be wired in balanced and unbalanced modes, which will be determined by the actual application status, Please wire your systems as the following examples:

- For 1/4" Phone jack

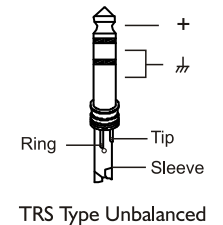
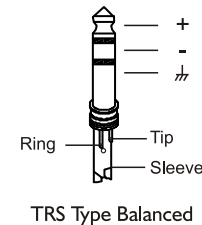
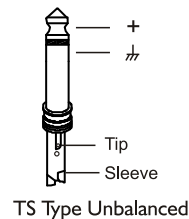

- For XLR connector

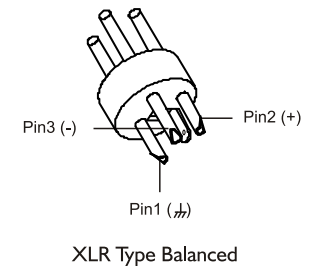
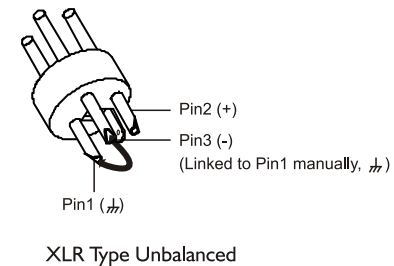

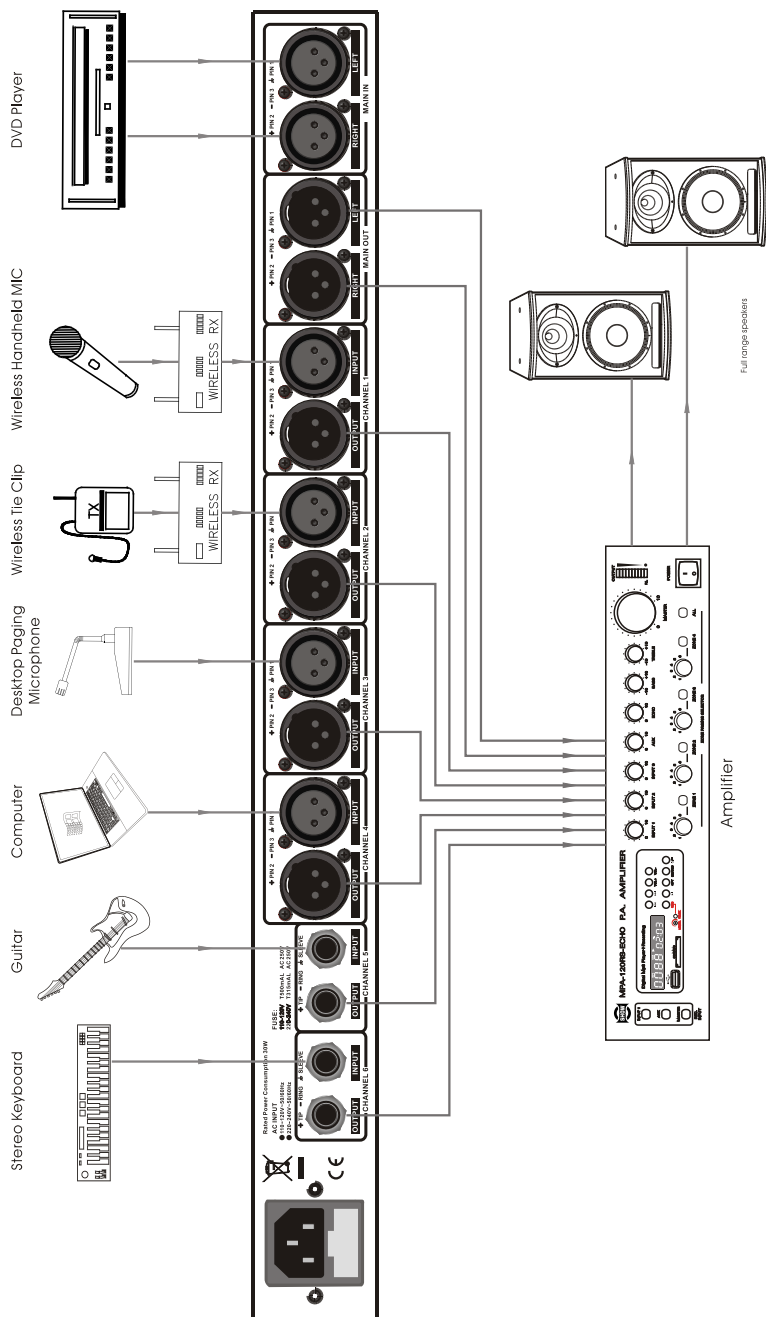

8. INPUT / OUTPUT LEVEL meter

This 6-digit meter tells you the output level of each mono channel, while the Clip LED lights up, please turn down the level control, otherwise, this channel will be distorted.

9. BALANCE / PAN control

Generally, the main section uses the stereo input and output, while, for each individual channel, mono application is configured. So, if the stereo main signal is split into the mono channel output, or the mono input signal is routed to the stereo main output bus, please use this knob to determine the proportion between the left and the right.

10. POWER SWITCH & POWER LED

This switch turns on/off the unit. When the unit is powered on, the LED will light up.

Rear Panel

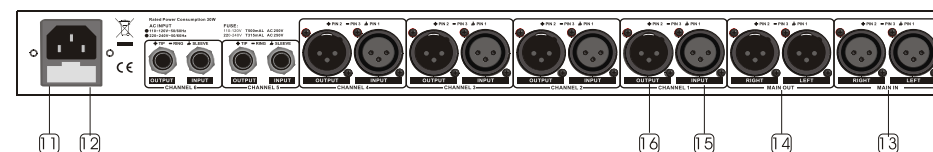

11. FUSE HOLDER

Before you attempt to connect and operate the unit, please make sure that your local voltage matches the voltage on the fuse-holder cover.

Caution: The fuse protecting the AC supplies circuits of this unit. The fuse can only be changed by a qualified technician, in the event of a fault or changing the supply voltage. If the fuse continues to blow after replacing, discontinue use of this unit before repaired.

12. AC inlet

This connector is meant for the connection of the supplied main cord. Do not insert power cable into the unit until the voltage has been correctly set. Do not plug power cable into AC power until voltage has been correctly set.

13. MAIN INPUTS

These two XLR balanced connectors are used to input the main stereo signal. In SPLITTER mode, it can be split into each mono channel output.

14. MAIN OUTPUTS

These two XLR balanced connectors are used to output the main stereo signal. By depressing the MAIN LINK, It can be linked with the MAIN IN directly.

15. INPUT for the mono channel

For Channel 1~4, use the XLR balanced connectors to input the mono signal, while, for Channel 5~6, please use the TRS type.

16. OUTPUT for the mono channel

For Channel 1~4, use the XLR balanced connectors to output the mono signal, while, for Channel 5~6, please use the TRS type.

APPLICATIONS

From the panel introduction on the chapter 3, you must have caught a clear answer to "What is it?" in your mind as to our S-LINK8, SPLITTER / MIXER, hereafter, we will show you the further explanation on "How to use it?", So that, you can be the real master of this unit.

How to use S-LINK8 as the splitter

Sometimes, in the large scale PA / sound reinforcement systems, you may be disturbed by this kind of problems: one pre-send signal needs to be monitored by several groups, or the main mix output of the console should be transited to several power amplifiers, etc. And now, with your S-LINK8, you will get the best solution.

Connect the S-LINK8 into your systems as the demonstrated, you can split a specific main input signal into up to 6 outputs. With the MAIN LINK button depressed, 2 further outputs are added.

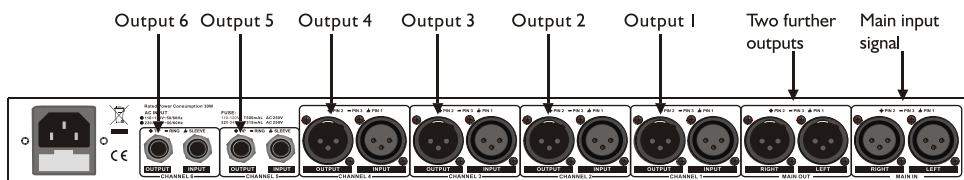

In this application, use the SPLIT/MIX switch to select the SPLITTER operational mode for each mono channel, apply the main signal from the MAIN IN sockets, and get the 6 outputs from the mono OUTPUT sockets of each channel. While the MAIN LINK is engaged, the MAIN OUT will also be linked with the MAIN IN signal, and two further outputs are provided.

How to use S-LINK8 as the mixer

This application is widely used for the mixing of one group main stereo signal with several mono signals.

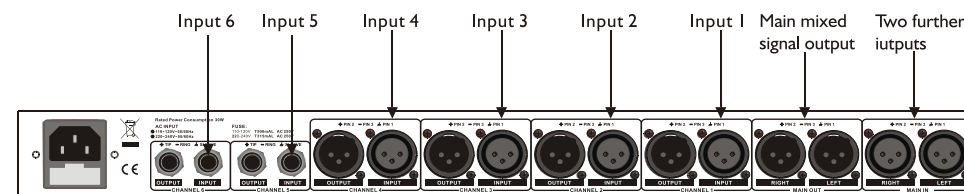

In this application, use the SPLIT/MIX switch to select the MIXER operational mode for each mono channel, input the signal from the mono INPUT of each channel, and output the main mixed signal from the MAIN OUT sockets. While the MAIN LINK is engaged, the MAIN IN will also be linked with the MAIN OUT signal, and two further input signals can be mixed with the main output signal.