

SEIKAKU TECHNICAL GROUP LIMITED

客 戶	SHWO														
料 號	NF05922														
品 名	說明書-英文														
規 格	MPA-4150 4250 SHOW_V1.1														
公司機種(客戶機種)成品料號	MPA-4150/MPA-4250														
重 量/ 基 數	0.015KG/1														
材 質	105G銅版紙 NH00231 1:1														
紙張展開性質	<input type="checkbox"/> A3 <input checked="" type="checkbox"/> A4 <input type="checkbox"/> A5 <input type="checkbox"/> 其它			紙張展開數量	3										
核 准	審 查	校 稿	製 稿												
產品文件編號:															
陽片數量: 6 張															
公差 ±2mm															
<table border="1"> <thead> <tr> <th>NO:</th> <th>修改記錄</th> <th>版本</th> <th>更改者</th> <th>日期</th> </tr> </thead> <tbody> <tr> <td>1</td> <td>依郵件變更印刷內容</td> <td>1.1</td> <td>鄧美燕</td> <td>2023.09.07</td> </tr> </tbody> </table>						NO:	修改記錄	版本	更改者	日期	1	依郵件變更印刷內容	1.1	鄧美燕	2023.09.07
NO:	修改記錄	版本	更改者	日期											
1	依郵件變更印刷內容	1.1	鄧美燕	2023.09.07											
變更單號: QHFBE004-20230900002															



THE UNIVERSE OF INSTALLATION

MULTIZONE PA. MIX POWER AMPLIFIER

User's Manual

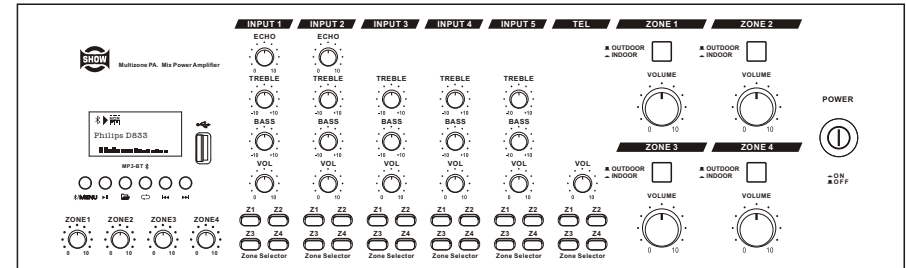

SHOW® is a registered trademark of
SEIKAKU TECHNICAL GROUP LIMITED

SEIKAKU TECHNICAL GROUP LIMITED

NO.1 LANE 17, SEC.2, HAN SHI WEST ROAD, TAICHUNG 40151, TAIWAN

tel: 886-4-22313737 - fax: 886-4-22346757

MPA-4150/MPA-4250

TABLE OF CONTENTS

01 SAFETY RELATED SYMBOLS	2
02 INTRODUCTION	4
03 CONTROL ELEMENTS	5
04 BLOCK DIAGRAM	8
05 CONNECTION DESCRIPTION	9
06 TECHNICAL SPECIFICATIONS	10

IMPORTANT!

Please read this manual carefully before operating this unit for the first time.

All rights reserved to SEIKAKU. All features and content might be changed without prior notice. Any photocopy, translation, or reproduction of part of this catalogue without written permission is forbidden. Copyright © 2009 SEIKAKU GROUP

TECHNICAL SPECIFICATIONS

Models		MPA-4150	MPA-4250
AC Power supply		110-120V~,220-240V~ 50Hz/60Hz	
Maximum power consumption	sine wave 1kHz,THD ≤ 1%,LOAD 4Ω	920W	1449W
Rated power consumption	sine wave 1kHz,THD ≤ 1%,LOAD 4Ω	700W	1000W
Rated output power	sine wave 1kHz,THD ≤ 1%,LOAD 4Ω	150W*4	250W*4
Sensitivity/Impedances	MIC 1~4(balanced)	-40dBV (±2dB)	-40dBV (±2dB)
	LINE 1~4(balanced)	-5dBV (±2dB)	-5dBV (±2dB)
	AUX(unbalanced)	-5dBV (±2dB)	-5dBV (±2dB)
	TEL	-15dBV (±2dB)	-15dBV (±2dB)
S/N ratio	MIC	> 65dB	> 65dB
	LINE	> 75dB	> 75dB
	AUX	> 75dB	> 75dB
Bandwidth	MIC+OUTDOOR	178Hz-7.96KHz	178Hz-7.96KHz
	MIC+INDOOR	132Hz-7.96KHz	132Hz-7.96KHz
	LINE+OUTDOOR	138Hz-12.6KHz	138Hz-12.6KHz
	LINE+INDOOR	70Hz-12.6KHz	70Hz-12.6KHz
	AUX+OUTDOOR	144Hz-17KHz	144Hz-17KHz
	AUX+INDOOR	76Hz-17KHz	76Hz-17KHz
THD+N	1/10 Rated Out/ 1W	≤ 1W	≤ 1W
Tone control	BASS @ 100 Hz	± 10dB	± 10dB
	TREBLE @ 10kHz	± 10dB	± 10dB
Phantom supply	condenser microphone	18V	18V
Priority Sensitivity	MIC+TEL	-60dBv/3S	-60dBv/3S
CMRR	balance input	> 60dB	> 60dB
Noise	all VR MAX	< 30mv	< 30mv

CONNECTION DESCRIPTION

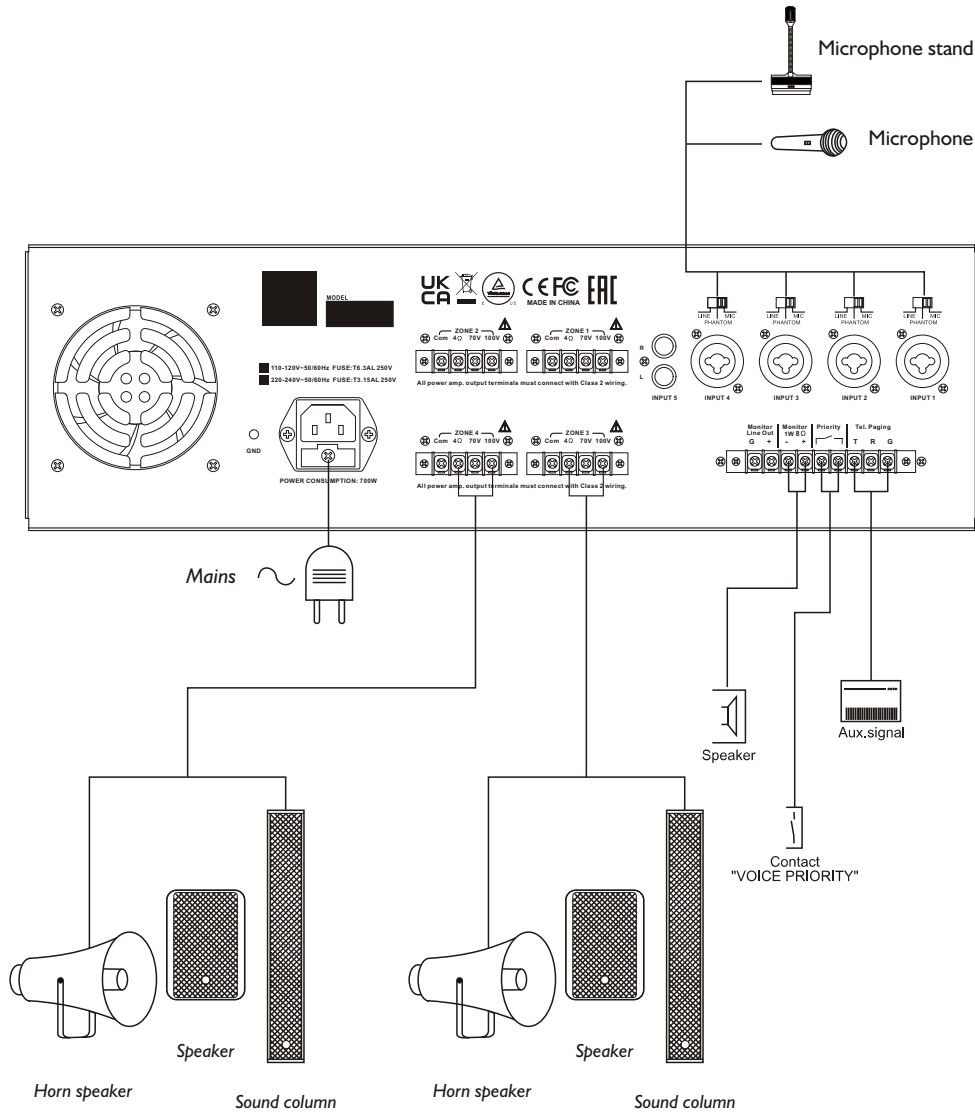

SAFETY RELATED SYMBOLS



The symbol is used to indicate that some hazardous live terminals are involved within this apparatus, even under the normal operating conditions.



The symbol is used in the service documentation to indicate that specific component shall be only replaced by the component specified in that Documentation for safety reasons.



Protective grounding terminal.



Alternating current /voltage.



Hazardous live terminal .

ON: Denotes the apparatus turns on.

OFF: Denotes the apparatus turns off, because of using the single pole switch, be sure to unplug the AC power to prevent any electric shock before you proceed your service.

WARNING: Describes precautions that should be observed to prevent the danger of injury or death to the user.



Disposing of this product should not be placed in municipal waste and should be separate collection.

CAUTION: Describes precautions that should be observed to prevent danger of the apparatus.

WARNING

• Power Supply

Ensure the source voltage matches the voltage of the power supply before turning ON the apparatus.

Unplug this apparatus during lightning storms or when unused for long periods of time.

• External Connection

The external wiring connected to the output hazardous live terminals requires installation by an instructed person, or the use of ready-made leads or cords.

• Do not Remove any Cover

There are maybe some areas with high voltages inside, to reduce the risk of electric shock, do not remove any cover if the power supply is connected.

The cover should be removed by the qualified personnel only.

No user serviceable parts inside.

• Fuse

To prevent a fire, make sure to use fuses with specified standard (current, voltage, type). Do not use a different fuse or short circuit the fuse holder.

Before replacing the fuse, turn OFF the apparatus and disconnected the power source.

• Protective Grounding

Make sure to connect the protective grounding to prevent any electric shock before turning ON the apparatus.

Never cut off the internal or external protective grounding wire or disconnect the wiring of protective grounding terminal.

• Operating Conditions

This apparatus shall not be exposed to dripping or splashing and that no objects filled with liquids, such as vases, shall be placed on this apparatus.

To reduce the risk of fire or electric shock, do not expose this apparatus to rain or moisture.

Do not use this apparatus near water. Install in accordance with the manufacturer's instructions. Do not install near any heat sources such as radiators, heat registers, stoves, or other apparatus (including amplifiers) that produce heat. Do not block any ventilation openings.

No naked flame sources, such as lighted candles, should be placed on the apparatus.

IMPORTANT SAFETY INSTRUCTIONS

- Read these instructions.
- Follow all instructions.
- Keep these instructions.
- Heed all warnings.
- Only use attachments/accessories specified by the manufacturer.

• Power Cord and Plug

Do not defeat the safety purpose of the polarized or grounding type plug.

A polarized plug has two blades with one wider than the other. A grounding type plug has two blades and a third grounding prong. The wide blade or the third prong are provided for your safety. If the provided plug does not fit into your outlet, consult an electrician for replacement of the obsolete outlet.

Protect the power cord from being walked on or pinched particularly at plugs, convenience receptacles, and the point where they exit from the apparatus.

• Cleaning

When the apparatus needs a cleaning, you can blow off dust from the apparatus with a blower or clean with rag etc.

Don't use solvents such as benzol, alcohol, or other fluids with very strong volatility and flammability for cleaning the apparatus body. Clean only with dry cloth.

• Servicing

Refer all servicing to qualified personnel. To reduce the risk of electric shock, do not perform any servicing other than that contained in the operating instructions unless you are qualified to do so.

Servicing is required when the apparatus has been damaged in any way, such as power supply cord or plug is damaged, liquid has been spilled or objects have fallen into the apparatus, the apparatus has been exposed to rain or moisture, does not operate normally, or has been dropped.

The mains plug is used as the disconnect device, the disconnect device shall remain readily operable.

This device complies with Part 15 of the FCC Rules. Operation is subject to the following two conditions: (1) this device may not cause harmful interference, and (2) this device must accept any interference received, including interference that may cause undesired operation.

FCC Statement:

"This equipment has been tested and found to comply with the limits for a Class B digital device, pursuant to part 15 of the FCC Rules. These limits are designed to provide reasonable protection against harmful interference in a residential installation. This equipment generates, uses and can radiate radio frequency energy and, if not installed and used in accordance with the instructions, may cause harmful interference to radio communications. However, there is no guarantee that interference will not occur in a particular installation. If this equipment does cause harmful interference to radio or television reception, which can be determined by turning the equipment off and on, the user is encouraged to try to correct the interference by one or more of the following measures:

- Reorient or relocate the receiving antenna.
- Increase the separation between the equipment and receiver.
- Connect the equipment into an outlet on a circuit different from that to which the receiver is connected.
- Consult the dealer or an experienced radio/TV technician for help."

BLOCK DIAGRAM

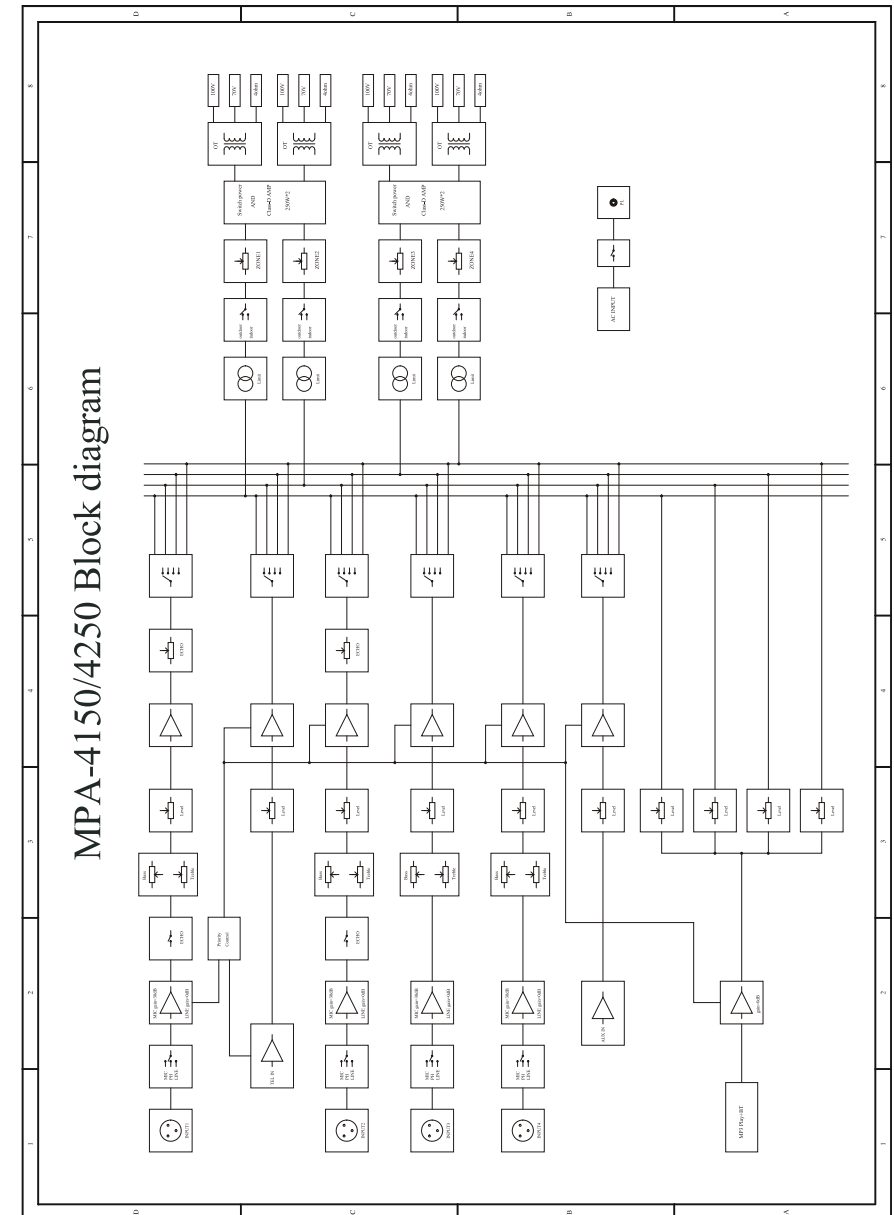

CONTROL ELEMENTS

3. REAR PANEL

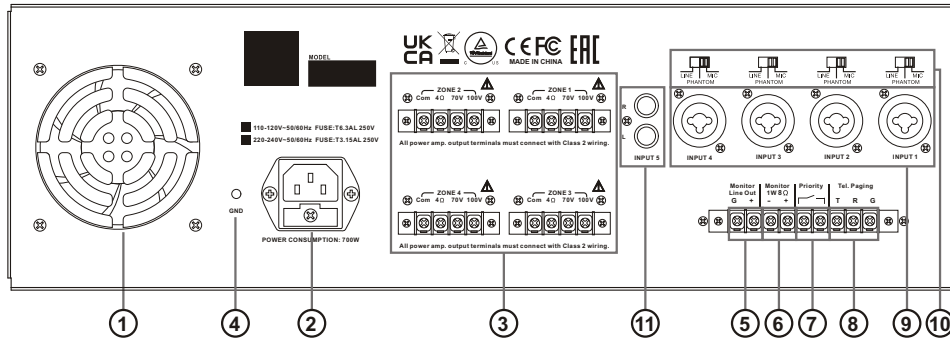

① FAN

It is used to blow off heat and cool when the temperature rises during operation.

② AC JACK

This connector is meant for connection of the supplied main cord.

Do not insert the power cord into this unit until voltage has been correctly set.

③ OUTPUT TERMINALS

Connection for low impedance 4 speaker; connections for constant voltage, 70V or 100V speakers.

④ GND

It is ground connection.

⑤ Monitor line out

This terminal allows you to connect other device, such as amplifier, recorder, etc.

⑥ 1W 8Ohm monitor

Use this terminal to connect small external speakers, which will be powered by an auxiliary power amplifier, offering a 1W of nominal output.

⑦ Priority terminal

When these terminals are in short circuit (e.g. Using an electrical switch), the audio signal from channels 2-5 are attenuated.

⑧ TEL paging input

Use these terminals to connect an auxiliary signal. The input features of Voice Priority function, which overrides all other input signals once, an auxiliary message is sent.

⑨ INPUT-4

They are used for balanced input, LINE and MIC respectively.

⑩ MIC/PHANTOM/LINE SELECT SWITCH

Select LINE input; MIC input; power supply for condenser microphone input

⑪ AUX INPUT

AUX unbalanced input

INTRODUCTION

Function introduction:

4 Zons Class D P.A. AMP series

- The class D professional public address amplifier series are designed for small hotels, super-market and schools.
- They have good performance and supply the excellent quality of sound. Besides, users can operate easily.
- The class D professional public address amplifier series have 7 inputs and 4 outputs
- The series includes the following models: MPA-4150 (150W*4)/MPA-4250 (250W*4).

The main functions are as follows :

Ahead panel:

- Input 1-Input 5 volume control; TEL volume control
- Input 1-Input 5 Bass and Treble control
- Input 1-Input 2 Echo function selection
- USB, Bluetooth, and MP3 ZONE 1 ZONE 2 ZONE 3 ZONE 4 volume knob
- ZONE 1 ZONE 2 ZONE 3 ZONE 4 master volume knob
- ZONE 1 ZONE 2 ZONE 3 ZONE 4 Bandwidth selection button

Rear panel:

- 4 channel MIC or line input. 1 AUX INPUT
- 4 channel MIC/line/phantom selection switch.
- Zone 1 - 4 output.
- Output can choose 4ohm/70V/100V
- AC Power supply input.
- Cooling fan.
- Monitor line out; 1W 8Ohm monitor; Priority terminal; TEL paging input

CONTROL ELEMENTS

Take the below model with MP3 player + ECHO for example.

I. FRONT PANEL

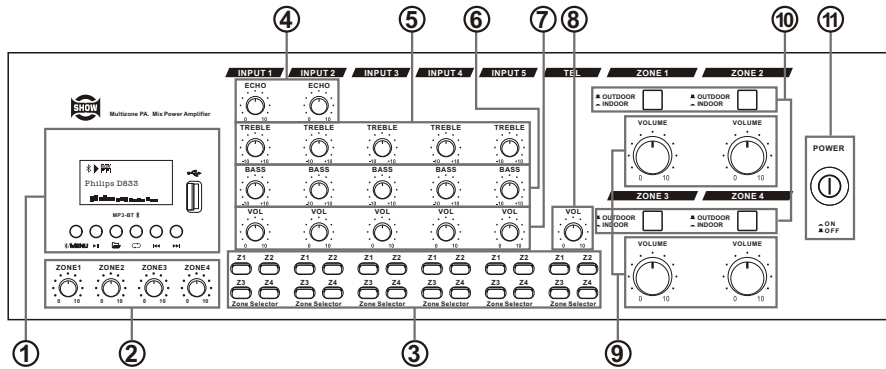

① MP3 MODULE

Regarding its function and operation, please see the BGM module description in detail.

② MP3 VOL Knobs

The knobs are used to adjust the gain of MP3. Adjust clockwise to increase the volume while adjust counterclockwise to decrease the volume.

③ Partition selection input button

Signals are assigned to Zone 1, Zone 2, Zone 3 and Zone 4 inputs respectively

④ ECHO FUNCTION

The ECHO function knob, the ECHO effect is turned clockwise, and the ECHO effect is attenuated counterclockwise.

⑤ TREBLE(INPUT 1-5)

Use the knob to control the high frequency at the range of 10dB. Turn clockwise to boost and counterclockwise to attenuate the treble response. Tone is flat at centre.

⑥ BASS(INPUT 1-4)

Use the knob to control the low frequency at the range of 10dB. Turn clockwise to boost and counterclockwise to attenuate the treble response. Tone is flat at centre.

⑦ INPUT 1-5 VOL Knobs

The knobs are used to adjust the gain of input 1-5 respectively. Adjust clockwise to increase the volume while adjust counter-clockwise to decrease the volume.

⑧ TEL VOLUME

Allows you to set the audio signal output volume from the phone line. When you don't use the phone line, we recommend to use the volume level to 0.

CONTROL ELEMENTS

⑨ ZONE1-4 master volume knob

This knob is used to adjust the ZONE1-4 gain of the unit.

⑩ Bandwidth selection button

	OUTDOOR	INDOOR
MIC: (1~4)	178Hz-7.96KHz	132Hz-7.96KHz
LINE: (1~4)	138Hz-12.6KHz	70Hz-12.6KHz
AUX(INPUT5)	144Hz-17KHz	76Hz-17KHz

⑪ POWER SWITCH

The main power can be switched on or off with it.

2. MP3 Operation Instructions

The Functions Description of USB PLAYER

Inputs Ports

USB:USB port

SD/MMC:SD/MMC cards port

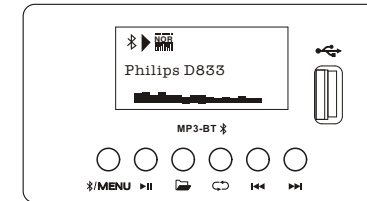

Control Keys

	ACTION	USB	BLUETOOTH
MENU	Short press	USB	ON
	Long press	OFF	OFF
PLAY/PAUSE	Short press	Play/Pause	Play/Pause
FILE	Short press	Browsing file	/
REPEAT	Short press	Repeat file(6 modes)	/
BACK	Short press	Previous file	Previous file
	Long press	Volume down	Volume down
NEXT	Short press	Next file	Next file
	Long press	Volume up	Volume up

Bluetooth Connection

When using a Bluetooth connection between the amplifier and other devices like smartphones, search the RTL-29 matching name and valid the connection.

Frequency range	Bluetooth: 2402-2480MHz
Maximum EIRP	Bluetooth: -4.07 dBm